



DICOM
CONFORMANCE STATEMENT
REVIEW

For use with
Version 4.0.0.12228

Canon Medical Systems (CMS)
A Division of Canon U.S.A., Inc.
15955 Alton Parkway
Irvine, CA 92618
(800) 970-7227

© Canon U.S.A., Inc. 2009
EUM-060, Rev. A

DICOM Conformance Statement: imageSPECTRUM Review

DICOM is the registered trademark of the National Electrical Manufacturers Association for its standards publications relating to digital communications of medical information.

Canon is a registered trademark of Canon Inc. in the United States and may be registered trademark or trademark in other countries.

All other referenced product names, and other works, are trademarks of their respective owners.

1. OVERVIEW

imageSPECTRUM Review is the Client component of a Client and Server Image Management system developed by Canon Medical Systems (CMS).

imageSPECTRUM Review implements necessary standard DICOM[®] compliant services to provide the following:

- Interface directly with DICOM query and retrieve servers (e.g. imageSPECTRUM Server) to retrieve patient lists and associated study data and images.
- Produce DICOM images as DICOM secondary capture images.
- Append existing studies with derived images from imageSPECTRUM Review.
- Append existing studies with derived images with corresponding private tags from imageSPECTRUM Review.

imageSPECTRUM Review implements non DICOM related processing to provide the following:

- View study images.
- Provide tools to manipulate and analyze study images.

[®] DICOM is the registered trademark of the National Electrical Manufacturers Association for its standards publications relating to digital communications of medical information.

1.1 Supported SOP Classes

Table 1-1 Supported SOP Classes

SOP Classes	User of Service (SCU)	Provider of Service (SCP)
Transfer		
Ophthalmic Photography 8 Bit Image Storage	No	Yes
Visible Light Photographic Image Storage	No	Yes
Secondary Capture	Yes	Yes
Query and Retrieve Workflow Management		
Patient Root C-FIND	Yes	No
Study Root C-MOVE	Yes	No
Verification		
Verification	Yes	Yes
Print Management		
Structured Reporting	No	No

2. TABLE OF CONTENTS

1. OVERVIEW	1
1.1 Supported SOP Classes	2
2. TABLE OF CONTENTS	3
3. TABLE OF TABLES	5
4. TABLE OF FIGURES	7
5. INTRODUCTION	9
5.1 Audience	9
5.2 Remarks	9
5.3 Definitions, Terms, and Abbreviations	9
5.4 References	10
6. NETWORKING	10
6.1 Implementation Model	10
6.1.1 Application Data Flow	10
6.1.2 Functional Definition of Application Entities	11
6.1.3 Sequencing of Real World Activities	12
6.2 Application Entity Specifications:	13
6.2.1 STORAGE SCP	13
6.2.2 Q/R SCU	17
6.2.3 STORAGE SCU	29
6.2.4 VERIFICATION SCU/SCP	34
6.3 Network Interfaces	36
6.3.1 Physical Network Interface	36
6.3.2 Additional Protocols	37
6.4 Configuration	37
6.4.1 AE Title Presentation Address Mapping	37
6.4.2 Parameters	43
7. MEDIA INTERCHANGE	44
8. SUPPORT OF CHARACTER SETS	44
9. SECURITY	44
9.1 Security Profiles	44
9.2 Association Level Security	44
9.3 Application Level Security	44
10. ANNEXES	45
10.1 IOD Contents	45

10.1.1	Storage SCP AE Element Use	45
10.1.2	Usage of Attributes from Received IODs.....	45
10.1.3	Attribute Mapping	45
10.1.4	Coerced/Modified fields	45
10.2	Appending Images.....	45
10.3	Data Dictionary of Private Attributes	60
10.3.1	Report Elements.....	60
10.3.2	Category.....	60
10.3.3	Field Name	60
10.3.4	Tag	60
10.3.5	Type	60
10.3.6	Value/Enumeration	61
10.3.7	Length	61
10.4	Coded Terminology and Templates.....	66
10.4.1	Template Specifications	66
10.4.2	Private Code definitions.....	66
10.5	Grayscale Image Consistency	66
10.6	Standard Extended/Specialized/Private SOP Classes	66
10.7	Private Transfer Syntaxes	66

3. TABLE OF TABLES

Table 1-1 Supported SOP Classes	2
Table 6-1 SOP Classes	14
Table 6-2 DICOM Application Context	14
Table 6-3 Number of Associations as an Association Initiator	14
Table 6-4 Number of Associations as an Association Acceptor	14
Table 6-5 DICOM Implementation Class and Version	15
Table 6-6 Proposed Presentation Context: STORAGE SCP	15
Table 6-7 Presentation Context Transfer Syntax for Storage SOP Classes	16
Table 6-8 Command Response Status Handling Behavior: STORAGE SCP	16
Table 6-9 Command Communication Failure Behavior: STORAGE SCP	17
Table 6-10 SOP Classes	17
Table 6-11 DICOM Application Context	17
Table 6-12 Number of Associations as an Association Initiator	17
Table 6-13 Number of Associations as an Association Acceptor	18
Table 6-14 DICOM Implementation Class and Version	18
Table 6-15 Proposed Presentation Context: Q/R SCU	23
Table 6-16 Patient Root C-FIND SCU Supported Elements	25
Table 6-17 Patient Root Q/R Information Model Find Behavior	26
Table 6-18 Study Root C-Move SCU Supported Elements	28
Table 6-19 Study Root Q/R Information Model Find Behavior	28
Table 6-20 DICOM Command Communication Failure Behavior	29
Table 6-21 SOP Classes	29
Table 6-22 DICOM Application Context	30
Table 6-23 Number of Associations as an Association Initiator	30

Table 6-24 Number of Associations as an Association Acceptor.....	30
Table 6-25 DICOM Implementation Class and Version	30
Table 6-26 Proposed Presentation Context: STORAGE SCU	33
Table 6-27 Command Response Status Handling Behavior: STORAGE SCU...	33
Table 6-28 Command Communication Failure Behavior: STORAGE SCU	33
Table 6-29 SOP Classes	34
Table 6-30 DICOM Application Context.....	34
Table 6-31 Number of Associations as an Association Initiator	34
Table 6-32 Number of Associations as an Association Acceptor.....	34
Table 6-33 DICOM Implementation Class and Version	35
Table 6-34 Proposed Presentation Context: VERIFICATION SCU	35
Table 6-35 Proposed Presentation Context: VERIFICATION SCP.....	36
Table 6-36 AE Title Configuration Table	37
Table 6-37 Configuration Elements.....	38
Table 6-38 Configuration Parameters Table	43
Table 10-1 Altering DICOM Elements when Modality = OP.....	47
Table 10-2 Altering DICOM Elements when Modality = XC.....	51
Table 10-3 Altering DICOM Elements when Modality = OT	54
Table 10-4 Report Form Elements and Values.....	61

4. TABLE OF FIGURES

Figure 1 imageSPECTRUM Review Data Flow Diagram.....	11
Figure 2 imageSPECTRUM Review/Server UML Sequence Diagram.....	12
Figure 3 Detailed Sequencing Diagram	13
Figure 4 Query Retrieve SCU - Query Sequence Diagram.....	20
Figure 5 Query Retrieve SCU - Retrieve Sequence Diagram	22
Figure 6 Storage SCU - Storage Request Sequence Diagram	32
Figure 7 Clone DICOM Header.....	46
Figure 8 Create New DICOM Header	46

THIS PAGE INTENTIONALLY LEFT BLANK

5. INTRODUCTION

5.1 Audience

The imageSPECTRUM Review DICOM Conformance Statement is intended for:

- Software Designers implementing DICOM interfaces
- System Integrators
- Marketing Staff
- Customers

Readers of this DICOM Conformance Statement are assumed to be familiar with the DICOM Standard.

5.2 Remarks

The DICOM Conformance Statement follows the contents and structure requirements of DICOM PS3.2.

5.3 Definitions, Terms, and Abbreviations

AE	Application Entity
CMS	Canon Medical Systems
DICOM	Digital Imaging and Communication in Medicine
ELE	Explicit VR Little Endian
ILE	Implicit VR Little Endian
IOD	Information Object Definition
NEMA	National Electrical Manufacturers Association
OP	Ophthalmic Photography
PDU	Protocol Data Unit
Q/R	Query and Retrieve
SCP	Service Class Provider
SCU	Service Class User

SOP	Service Object Pair
TCP/IP	Transmission Control Protocol/Internet Protocol
UID	Unique Identifier
UML	Unified Modeling Language

5.4 References

DICOM Standard	The Digital Imaging and Communications in Medicine (DICOM) standard (NEMA PS 3.X): National Electrical Manufacturers Association (NEMA) Publication Sales 1300 N. 17th Street, Suite 1847 Rosslyn, VA 22209, United States of America.
----------------	--

6. NETWORKING

6.1 Implementation Model

6.1.1 Application Data Flow

The imageSPECTRUM Review will act as a DICOM image viewer, requesting and displaying study images. Tools shall be provided for image manipulation and analysis, deriving new images that are stored temporarily on the client machine. Any of the derived images can be appended to its corresponding study, resident on the imageSPECTRUM Server.

imageSPECTRUM Review functionality includes image manipulation functions, information request processing and image transfer. See Figure 1.

imageSPECTRUM Review AE is responsible for supporting the following DICOM services as an SCU:

- Verification (C-ECHO)
- Q/R (C-FIND/C-MOVE)
- Storage (C-STORE)

imageSPECTRUM Review AE is responsible for supporting the following DICOM services as an SCP:

- Verification (C-ECHO)
- Storage (C-STORE)

The division of imageSPECTRUM Review into the separate DICOM Application Entities represents an arbitrary partitioning of functionality. For the purpose of

this document they are organized in this manner so as to detail their independent logical functionality.

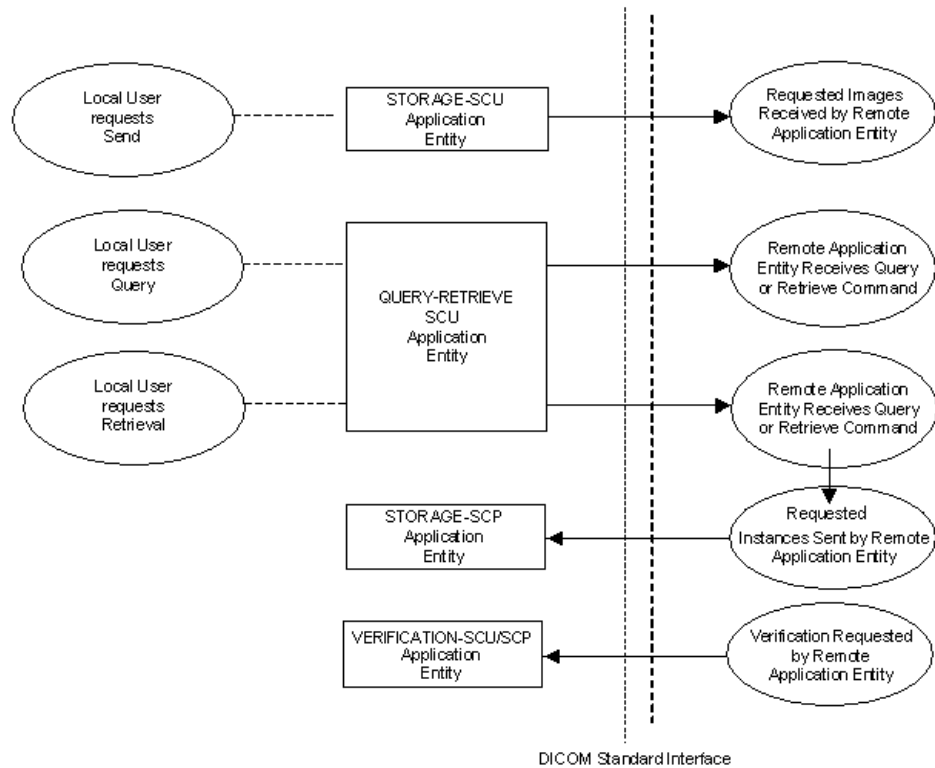

Figure 1 imageSPECTRUM Review Data Flow Diagram

All of the defined Application Entities have the same configurable AE Title. In a multi-client environment each AE Title shall be unique and the title shall be case sensitive.

6.1.2 Functional Definition of Application Entities

6.1.2.1 Functional Definition of STORAGE SCP Application Entity

Review functions may request images/data be transferred for viewing and image manipulation. imageSPECTRUM Server will fulfill the request and transfer the images to the STORAGE SCP.

6.1.2.2 Functional Definition of Q/R SCU Application Entity

Review functions will request patient and study lists relating to the images and data managed by imageSPECTRUM Server. imageSPECTRUM Server will supply these patient lists, selected as per request.

6.1.2.3 Functional Definition of STORAGE SCU Application Entity

Review functions transfer user specified derived images to the imageSPECTRUM Server for storage management as additions to existing studies.

6.1.2.4 Functional Definition of VERIFICATION SCU/SCP Application Entity

imageSPECTRUM Review will transmit a C-ECHO message and the Registered AE Title will respond. Registered AE Titles will transmit a C-ECHO message and imageSPECTRUM Review will respond.

6.1.3 Sequencing of Real World Activities

The following diagram is a UML sequence diagram depicting an overview of the interactions of various AE's:

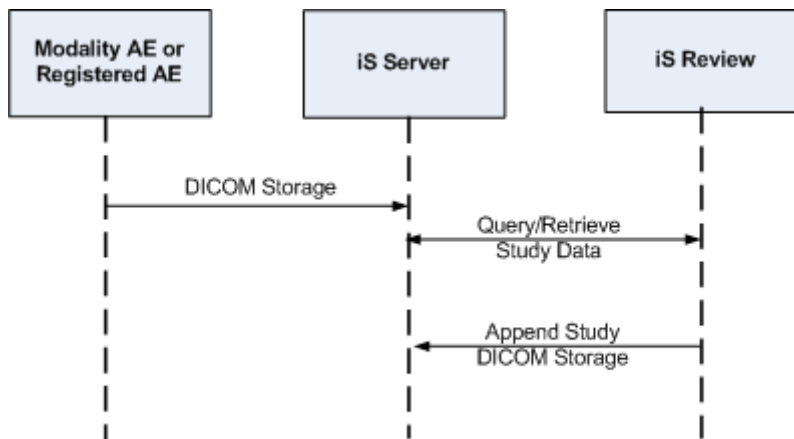

Figure 2 imageSPECTRUM Review/Server UML Sequence Diagram

imageSPECTRUM Review will act as a DICOM image viewer, requesting and displaying study images. Tools shall be provided for image manipulation and analysis, deriving new images that are stored temporarily on the client machine. Any of the derived images can be appended to its corresponding study resident on the imageSPECTRUM Server. See Figure 2.

The following diagram is a UML sequence diagram depicting a detailed view of interactions of the various AE's. The VERIFICATION SCU and VERIFICATION SCP are not depicted as it is a simple retrieve→response interaction without sequencing issues.

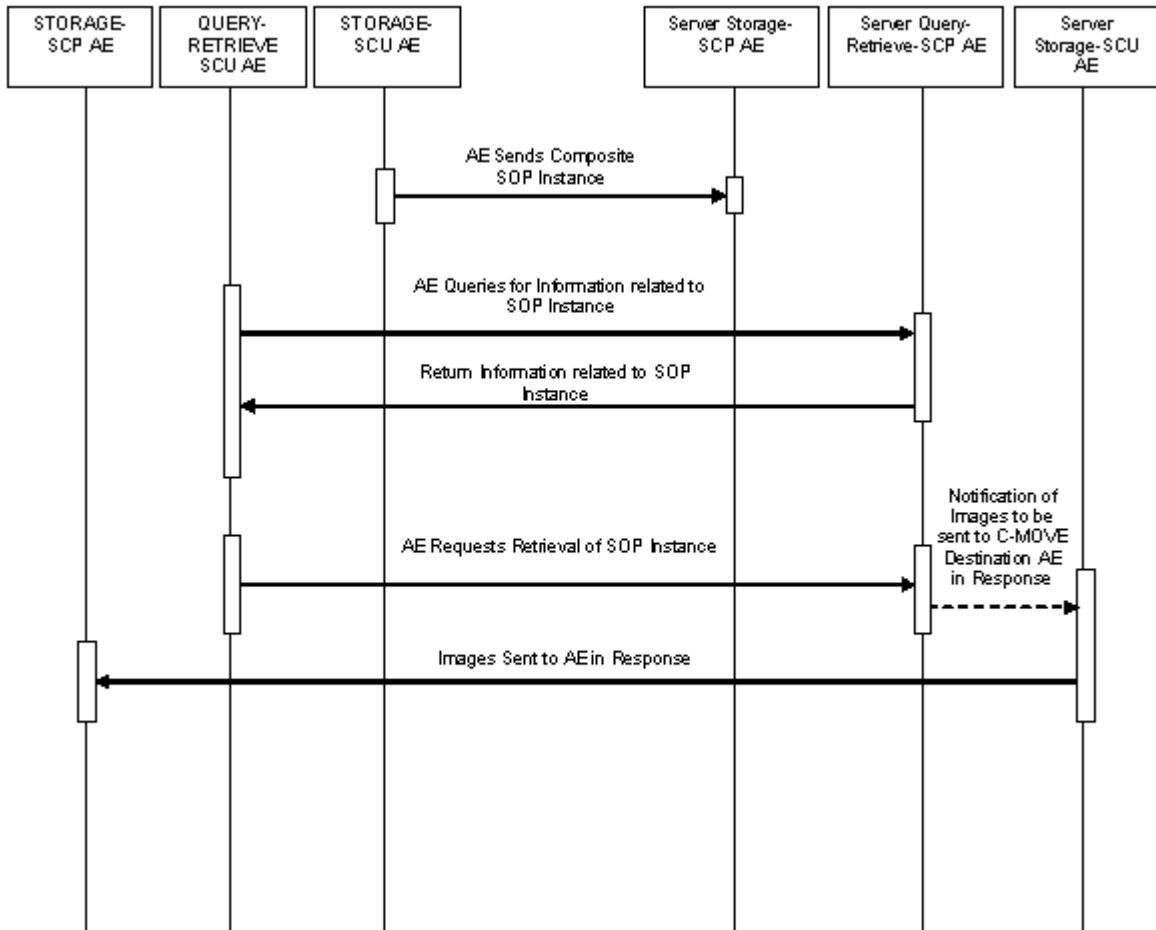

Figure 3 Detailed Sequencing Diagram

Note that the only constraint is for the Composite SOP Instance to be processed by the Server Storage SCP AE prior to the other events. All SCP activities are performed in the background and not dependent on any sequencing. All SCU activities are sequentially initiated in the user interface, and another activity may not be initiated until the prior activity has completed.

6.2 Application Entity Specifications:

6.2.1 STORAGE SCP

6.2.1.1 Service-Object Pair (SOP) Classes

The STORAGE SCP AE provides standard conformance to the following DICOM V3.0 SOP Classes. See Table 6-1.

Table 6-1 SOP Classes

SOP Class Name	SOP Class UID	SCU	SCP
Ophthalmic Photography 8 bit Image Storage	1.2.840.10008.5.1.4.1.1.77.1.5.1	No	Yes
Secondary Capture Image Storage	1.2.840.10008.5.1.4.1.1.7	No	Yes
Visible Light Photographic Image Storage	1.2.840.10008.5.1.4.1.1.77.1.4	No	Yes

These are the default SOP Classes supported. By altering the configuration, it is possible to support additional, or fewer, SOP Classes.

6.2.1.2 Association Policies

6.2.1.2.1 General

The DICOM standard Application Context shall be specified as detailed in Table 6-2.

Table 6-2 DICOM Application Context

Application Context Name	1.2.840.10008.3.1.1.1
--------------------------	-----------------------

6.2.1.2.2 Number of Associations

STORAGE SCP accepts up to 1 simultaneous association establishment requests for Storage. See Table 6-3 and Table 6-4.

Table 6-3 Number of Associations as an Association Initiator

Maximum number of simultaneous associations	0
---	---

Table 6-4 Number of Associations as an Association Acceptor

Maximum number of simultaneous associations	1
---	---

6.2.1.2.3 Asynchronous Nature

Not Supported.

6.2.1.2.4 Implementation Identifying Information

Table 6-5 contains implementation identifying information for imageSPECTRUM Review.

Table 6-5 DICOM Implementation Class and Version

Implementation Class UID	a.b.c.xxxxxxx.yyy.zz
Implementation Version Name	1.2.828.0.1.3680043.2.60.0.1

6.2.1.3 Association Initiation Policy

STORAGE SCP does not initiate associations.

6.2.1.4 Association Acceptance Policy

6.2.1.4.1 Activity: Receive Images and Associated Data for Storage

6.2.1.4.2 Description and Sequencing of Activities

As instances are received they are copied to the local file system.

The C-MOVE request will contain the Study Specification associated with the images requested, and the STORAGE SCP (Destination AE) information.

The Query Retrieve Server will trigger the transfer of each associated image after opening an Association to the STORAGE SCP (Destination AE). The DICOM Q/R Server will be responsible for closing the Association with the STORAGE SCP.

The C-MOVE/C-STORE sequence is illustrated in steps 3 through 5 of

Figure 5 (see page 22).

6.2.1.4.3 Accepted Presentation Contexts

imageSPECTRUM Review STORAGE SCP is capable of accepting the Presentation Contexts shown in Table 6-6.

Table 6-6 Proposed Presentation Context: STORAGE SCP

Presentation Context Table				
Abstract Syntax		Transfer Syntax	Role	Extended Negotiation
Name	UID			
Ophthalmic Photography 8 bit Image Storage	1.2.840.10008.5.1.4.1.1.77.1.5.1	Table 6-7	SCP	None

Presentation Context Table				
Abstract Syntax		Transfer Syntax	Role	Extended Negotiation
Name	UID			
Visible Light Photographic Image Storage	1.2.840.10008.5.1.4.1.1.77.1.4	Table 6-7	SCP	None
Secondary Capture Image Storage	1.2.840.10008.5.1.4.1.1.7	Table 6-7	SCP	None

Table 6-7 Presentation Context Transfer Syntax for Storage SOP Classes

Transfer Syntax Table	
Name	UID
Implicit Little Endian (default)	1.2.840.10008.1.2
Explicit Little Endian	1.2.840.10008.1.2.1
Baseline JPEG	1.2.840.10008.1.2.4.50
Lossless, Non-hierarchical, First-order (default)	1.2.840.10008.1.2.4.70

6.2.1.4.4 SOP Specific Conformance for Storage SOP Classes

STORAGE SCP provides DICOM conformance to the Storage Service Class. The behavior of imageSPECTRUM Review STORAGE SCP is summarized in Table 6-8.

Table 6-8 Command Response Status Handling Behavior: STORAGE SCP

Status	Further Meaning	Error Code	Further Information
Success	Process complete.	0000	Message was received successfully.
Warning	One or more errors.	B000	Server returns response.
Failure	Out of resources.	A700	Insufficient storage.
	Unable to process.	C000	Server returns response.

The behavior of imageSPECTRUM Review STORAGE SCP during communication failure is summarized in Table 6-9.

Table 6-9 Command Communication Failure Behavior: STORAGE SCP

Exception	Behavior
Timeout	The reason is logged and reported to the user.
Abort	The command is marked as failed. The reason is logged and reported to the user.

6.2.2 Q/R SCU

6.2.2.1 Service-Object Pair (SOP) Classes

The Q/R SCU AE provides DICOM conformance to the following DICOM V3.0 SOP Classes.

Table 6-10 SOP Classes

SOP Class Name	SOP Class UID	SCU	SCP	Level
Patient Root Q/R Information Model FIND	1.2.840.10008.5.1.4.1.2.1.1	Yes	No	Patient
Patient Root Q/R Information Model FIND	1.2.840.10008.5.1.4.1.2.1.1	Yes	No	Study
Study Root Q/R Information Model MOVE	1.2.840.10008.5.1.4.1.2.2.2	Yes	No	Image

6.2.2.2 Association Policies

6.2.2.2.1 General

The DICOM standard Application Context is specified as detailed in Table 6-11.

Table 6-11 DICOM Application Context

Application Context Name	1.2.840.10008.3.1.1.1
--------------------------	-----------------------

6.2.2.2.2 Number of Associations

Q/R SCU initiates up to one simultaneous association establishment requests. See Table 6-12 and Table 6-13.

Table 6-12 Number of Associations as an Association Initiator

Maximum number of simultaneous associations	1
---	---

Table 6-13 Number of Associations as an Association Acceptor

Maximum number of simultaneous associations	0
---	---

6.2.2.2.3 Asynchronous Nature

Not Supported.

6.2.2.2.4 Implementation Identifying Information

Table 6-14 contains implementation identifying information for imageSPECTRUM Review.

Table 6-14 DICOM Implementation Class and Version

Implementation Class UID	a.b.c.xxxxxxx.yyy.zz
Implementation Version Name	1.2.828.0.1.3680043.2.60.0.1

6.2.2.3 Association Initiation Policy

6.2.2.3.1 Activity Processing Query and Retrieve Requests

6.2.2.3.2 Description and Sequencing of Activities

The Q/R SCU generates requests for patient and study lists and their respective data and images.

All requests and their responses are processed by the Q/R SCU. There are two types of requests that are generated by the Q/R SCU: C-FIND and C-MOVE requests.

The C-FIND request contains the query type and query level requested and attributes used for matching. There are three types of C-FIND query supported by the Q/R SCU: Patient Root Patient Level, Patient Root Study Level, and Patient Root Study Level (relational) with a date constraint. The response to a Patient Root Patient Level query will contain the patient information associated with the matching criteria designated in the query request. The response to a Patient Root Study Level query contains the study information associated with a matching patient. The response to a Patient Root Study Level query with a date constraint contains the patient and study information associated with the matching criteria designated in the query request. The Patient List Q/R SCU is responsible for opening and closing the association created for the C-FIND operation.

The Q/R SCU supports the Study Root Image Level C-MOVE request. The C-MOVE request will contain the study information associated with the images requested, and the Destination AE (STORAGE SCP) information. The response to the Study Root Image Level C-MOVE request will contain the image

information associated with the matching study. The DICOM Q/R Server will transfer the images to the STORAGE SCP. The DICOM Q/R Server will be responsible for closing the association with the STORAGE SCP.

Q/R SCU implements the following sequence of activities for a query request:

1. The Q/R SCU opens an association with the Q/R Server.
2. The Q/R SCU sends a C-FIND query to the Q/R Server.
3. The Q/R Server queries its data store using the attributes from the C-FIND request and returns 0-n C-FIND responses depending on the matches returned from the data store.
4. The Q/R Server sends the final C-FIND response with the appropriate status indication.
5. The Q/R SCU closes the association.

This sequence is illustrated in Figure 4.

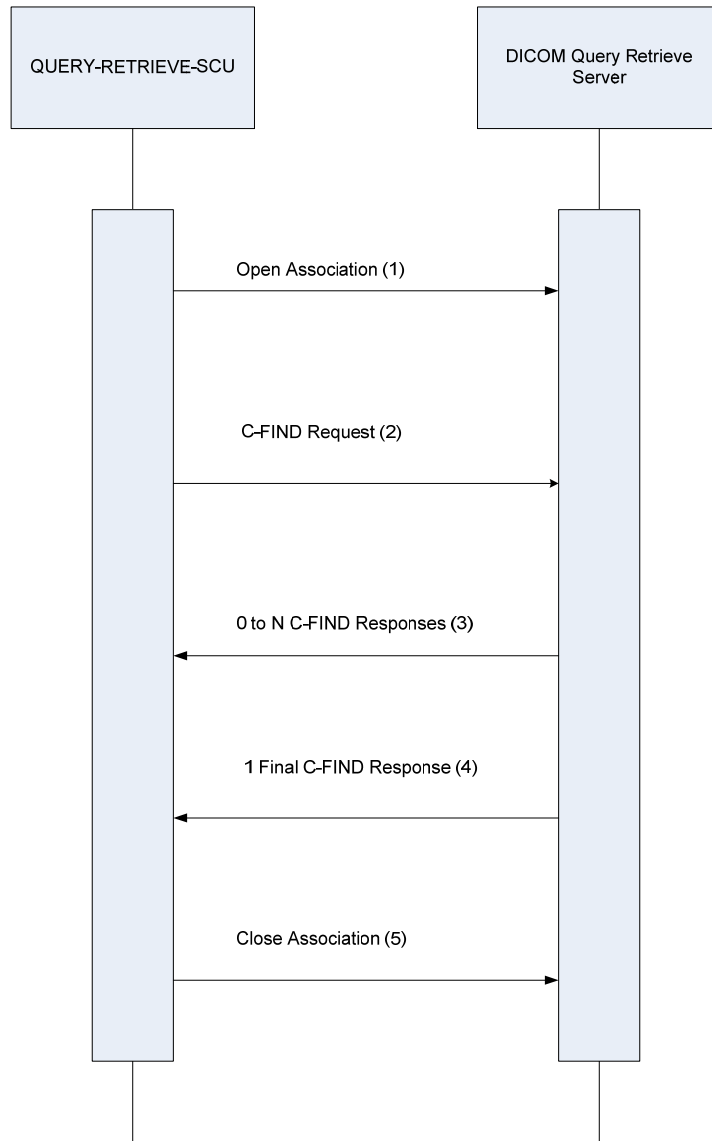

Figure 4 Query Retrieve SCU - Query Sequence Diagram

Q/R SCU implements the following sequence of activities for a retrieve request (C-MOVE).

1. The Q/R SCU opens an Association with Q/R Server for a C-MOVE request.
2. The Q/R SCU sends a C-MOVE request to the Q/R Server. The C-MOVE request contains the Destination AE (STORAGE SCP) information.
3. The Q/R Server opens an Association with the Destination AE (STORAGE SCP).
4. The Q/R Server transfers the requested study information and images to the STORAGE SCP using a C-STORE operation. In this sequence diagram there is one C-STORE operation per association depicted. The STORAGE SCP (Destination AE) sends a C-STORE response along the existing Association.
5. The Q/R Server closes the Association when the C-STORE dataset has been transferred to the STORAGE SCP. The sequence detailed in steps 3 through 5 is repeated until all datasets associated with the C-MOVE request have been processed.
6. The Q/R Server sends the final C-MOVE response with the appropriate status indication via the C-MOVE request association.
7. The Q/R SCU closes the C-MOVE request association.

This sequence is illustrated in Figure 5.

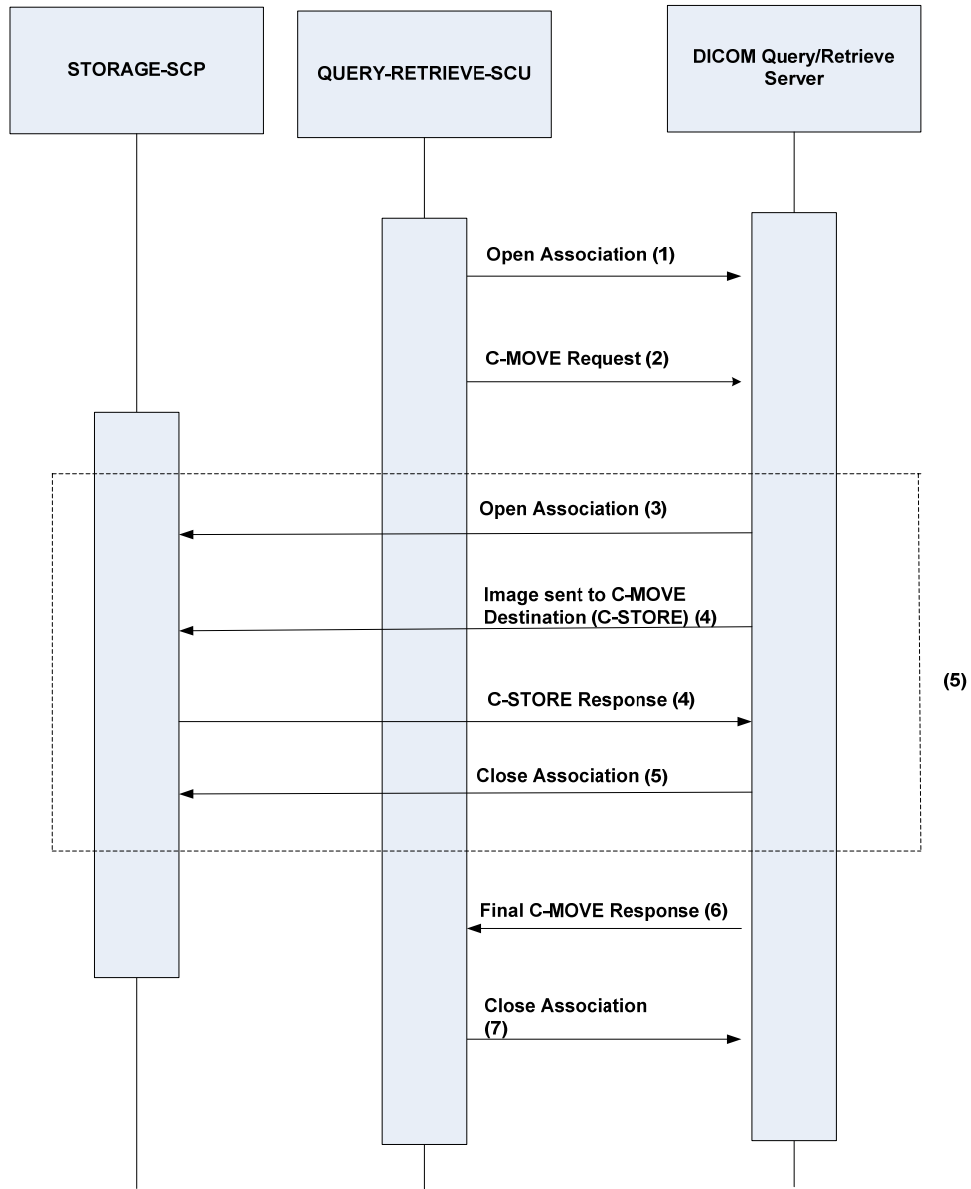

Figure 5 Query Retrieve SCU - Retrieve Sequence Diagram

6.2.2.3.3 Proposed Presentation Contexts

imageSPECTRUM Review Q/R SCU is capable of proposing the Presentation Contexts shown in Table 6-15.

Table 6-15 Proposed Presentation Context: Q/R SCU

Presentation Context Table					
Abstract Context		Transfer Context		Role	Extended Negotiation
Name	UID	Name List	UID List		
Patient Root Q/R Information Model - FIND	1.2.840.10008.5.1. 4.1.2.1.1	Implicit VR Little Endian	1.2.840.10008.1.2	SCU	None for non- relational queries; Relational flag required for relational Patient Root – Study Level queries
		Explicit VR Little Endian	1.2.840.10008.1.2.1		
Study Root Q/R Information Model - MOVE	1.2.840.10008.5.1. 4.1.2.2.2	Implicit VR Little Endian	1.2.840.10008.1.2	SCU	None
		Explicit VR Little Endian	1.2.840.10008.1.2.1		

6.2.2.3.4 SOP Specific Conformance for Query SOP Classes

The Patient Root and Study Root information models are supported.

Query will be initiated at the PATIENT and STUDY levels depending on user input.

No “cancel” requests are ever issued.

Only those attributes listed in Table 6-16 are returned. Query responses return values from the imageSPECTRUM Server database. Exported SOP Instances are updated with the latest values in the database prior to export. Thus, a change in patient demographic information will be contained in both the C-FIND responses and any composite SOP Instances exported to a C-MOVE destination AE.

6.2.2.3.5 Patient Root Information Model

The Patient Root Information Model search levels supported by the imageSPECTRUM Review-Q/R SCU are the patient level, and the study level. All required search keys on the two levels are supported.

The query elements supported by imageSPECTRUM Review-Q/R SCU are summarized in Table 6-16.

The following Value Representation (VR) definitions are used for Table 6-16.

Attribute Name	Query attributes supported by the imageSPECTRUM Review Q/R SCU.	
Tag	DICOM attribute tag.	
VR	Value Representation.	
Types of Matching	S	Single value
	*	Wildcard
	U	Universal
	R	Range
	None	no matching supported but values can be returned.
Return	Return keys. An “X” will indicate that the SCP will supply this attribute as part of its response.	
Display	Displayed attributes. An “X” will indicate that the key values will be displayed to the imageSPECTRUM Review user.	

The following Value Representation (VR) definitions are used in Table 6-16.

AE	Application Entity
CS	Code String
DA	Date
FL	Floating Point Single
LO	Long String
LT	Long Text
PN	Person Name
SQ	Sequence of Items
TM	Time
UI	Unique Identifier (UID)

Table 6-16 Patient Root C-FIND SCU Supported Elements

Level Name Attribute Name	Tag	VR	Types of Matching	Return	Display
SOP Common					
Specific Character Set	(0008,0005)	LO	None		
Patient Level					
Patient Name	(0010,0010)	PN	S,*,U	X	X
Patient ID	(0010,0020)	LO	S,*,U	X	X
Patient Birth Date	(0010,0030)	DA	None	X	X
Patient Birth Time	(0010,0032)	TM	None	X	
Patient Sex	(0010,0040)	CS	None	X	X
Patient Ethnicity	(0010,2160)	CS	None	X	X
Study Level					
Study Date	(0008,0020)	DA	R	X	X
Study Time	(0008,0030)	TM	None	X	X
Accession Number	(0008,0050)	SH	None	X	X
Study ID	(0020,0010)	SH	None	X	
Study Instance UID	(0020,000D)	UI	None	X	X
Referring Physician's Name	(0008,0090)	PN	None	X	X
Study Description	(0008,1030)	LO	None	X	X
Institution Name	(0008,0080)	LO	None	X	X

The behavior of imageSPECTRUM Review Q/R SCU during Patient Root Q/R Information Model Find communication is summarized in Table 6-17.

Table 6-17 Patient Root Q/R Information Model Find Behavior

Service Status	Further Meaning	Error Code	Behavior
Success	Process complete.	0000	Message was received successfully.
Warning	Unable to process.	B000	Return response and continue.
Failure	Database not operational.	C000	Return response and continue.

6.2.2.3.6 SOP Specific Conformance for Retrieval SOP Classes

Only the Study Root information model is supported.

Retrieval will be performed at the image level.

No “cancel” requests are ever issued.

The retrieval is performed from the AE that was specified in the Retrieve AE attribute returned from the query performed by the FIND SCU. The instances are retrieved to the current application’s local data store by specifying the destination as the AE Title of the STORAGE SCP AE of imageSPECTRUM Review. This implies that the server’s Q/R SCP must be preconfigured to determine the presentation address corresponding to the STORAGE SCP AE. The STORAGE SCP AE accepts storage requests addressed to it from registered AE’s making pre-configuration of the local application to accept from the server’s Q/R SCP AE necessary.

One or more of the Image Storage Presentation Contexts listed in Table 6-21 will be negotiated.

An initial C-MOVE response is always sent after confirming that the C-MOVE request itself can be processed. After this, the server’s Q/R SCP AE will return a final response to the Q/R SCU after the server’s STORAGE SCU AE has finished processing.

6.2.2.3.7 Study Root Information Model

The Study Root information Model search level supported by the imageSPECTRUM Review-Q/R SCU is the image level. All required search keys on this level are supported.

The query elements supported by imageSPECTRUM Review-Q/R SCU are summarized in Table 6-18.

The following Value Representation (VR) definitions are used for Table 6-16.

Attribute Name	Query attributes supported by the imageSPECTRUM Review Q/R SCU.	
Tag	DICOM attribute tag.	
VR	Value Representation.	
Types of Matching	S	Single value
	*	Wildcard
	U	Universal
	R	Range
	None	No matching supported but values can be returned.
Return	Return keys. An “X” will indicate that the SCP will supply this attribute as part of its response.	
Display	Displayed attributes. An “X” will indicate that the key values will be displayed to the imageSPECTRUM Review user.	

The following Value Representation (VR) definitions are used in Table 6-16.

AE	Application Entity
CS	Code String
DA	Date
FL	Floating Point Single
LO	Long String
LT	Long Text
PN	Person Name
SQ	Sequence of Items
TM	Time
UI	Unique Identifier (UID)

Table 6-18 Study Root C-Move SCU Supported Elements

Level Name Attribute Name	Tag	VR	Types of Matching	Return	Display
SOP Common					
Specific Character Set	(0008,0005)	LO	None		
Image Level					
Image Time	(0008,0033)	TM	None	X	X
Laterality	(0020,0062)	CS	None	X	X
Image Number	(0020,0013)	SH	None	X	
Spherical Lens Power	(0022,0007)	FL	None	X	X
Cylinder Lens Power	(0022,0008)	FL	None	X	X
Cylinder Axis	(0022,0009)	FL	None	X	X
Intra Ocular Pressure	(0022,000B)	FL	None	X	X
Dilated	(0022,000D)	CS	None	X	X
Degree of Dilation	(0022,000E)	FL	None	X	X
Mydriatic Agent	(0022,001C)	SQ	None	X	X
SOP Instance UID	(0008,0018)	UI	None	X	
SOP Class UID	(0008,0016)	UI	None	X	

The behavior of imageSPECTRUM Review’s Q/R SCU during Study Root Q/R Information Model Move communication is summarized in Table 6-19.

Table 6-19 Study Root Q/R Information Model Find Behavior

Service Status	Further Meaning	Error Code	Behavior
Success	Process complete.	0000	Message was received successfully.

Service Status	Further Meaning	Error Code	Behavior
Warning	One or more errors.	B000	Return response and continue.
Failure	Out of resources – one or more successful transfers.	A702	Return response and continue.
	Unable to process. Database not operational.	C000	Return response and continue.

The behavior of imageSPECTRUM Review’s Q/R SCU during communication failure is summarized in Table 6-20:

Table 6-20 DICOM Command Communication Failure Behavior

Exception	Behavior
Timeout	The reason is logged and reported to the user.
Abort	The command is marked as failed. The reason is logged and reported to the user.

6.2.2.4 Association Acceptance Policy

Q/R SCU does not accept associations.

6.2.3 STORAGE SCU

6.2.3.1 Service-Object Pair (SOP) Classes

The STORAGE SCU AE provides DICOM conformance to the following DICOM V3.0 SOP Classes.

Table 6-21 SOP Classes

SOP Class Name	SOP Class UID	SCU	SCP
Secondary Capture Image Storage	1.2.840.10008.5.1.4.1.1.7	Yes	No

These are the default SOP Classes supported. By altering the configuration it is possible to support additional or fewer SOP Classes.

6.2.3.2 Association Policies

6.2.3.2.1 General

The DICOM Application Context shall be specified as detailed in Table 6-22.

Table 6-22 DICOM Application Context

Application Context Name	1.2.840.10008.3.1.1.1
--------------------------	-----------------------

6.2.3.2.2 Number of Associations

STORAGE SCU initiates up to one simultaneous association establishment requests for storage. See Table 6-23 and Table 6-24.

Table 6-23 Number of Associations as an Association Initiator

Maximum number of simultaneous associations	1
---	---

Table 6-24 Number of Associations as an Association Acceptor

Maximum number of simultaneous associations	0
---	---

6.2.3.2.3 Asynchronous Nature

Not Supported.

6.2.3.2.4 Implementation Identifying Information

Table 6-25 contains implementation identifying information for imageSPECTRUM Review.

Table 6-25 DICOM Implementation Class and Version

Implementation Class UID	a.b.c.xxxxxxx.yyy.zz
Implementation Version Name	1.2.828.0.1.3680043.2.60.0.1

6.2.3.3 Association Initiation Policy

6.2.3.3.1 Activity: Send Images

6.2.3.3.2 Description and Sequencing of Activities

This component generates requests to move study information and images to a designated storage server (e.g., imageSPECTRUM Server).

The Review “append” functionality will trigger the imageSPECTRUM Review STORAGE SCU to transfer the specified images after opening a new association to the designated storage server. The STORAGE SCU is responsible for closing the association with the storage server.

Reports generated by imageSPECTRUM Review are transferred as jpeg images to the imageSPECTRUM Server. The Report dataset contains a Referenced Study Sequence (0008,1110). The Referenced Study Sequence (0008,1110) contains the Referenced SOP Class UID (0008,1150) and Referenced SOP Instance UID (0008,1155) for each existing dataset in the Report’s associated study.

STORAGE SCU implements the following sequence of activities:

1. The STORAGE SCU opens an association with a DICOM storage server.
2. The STORAGE SCU sends a C-STORE request to the DICOM storage server.
3. Storage server returns a C-STORE response.
4. The STORAGE SCU closes the association.
5. In Figure 6 there is one request↔response per opened association.

Performance for the storage SCU is measured on request↔response time versus total time for study storage.

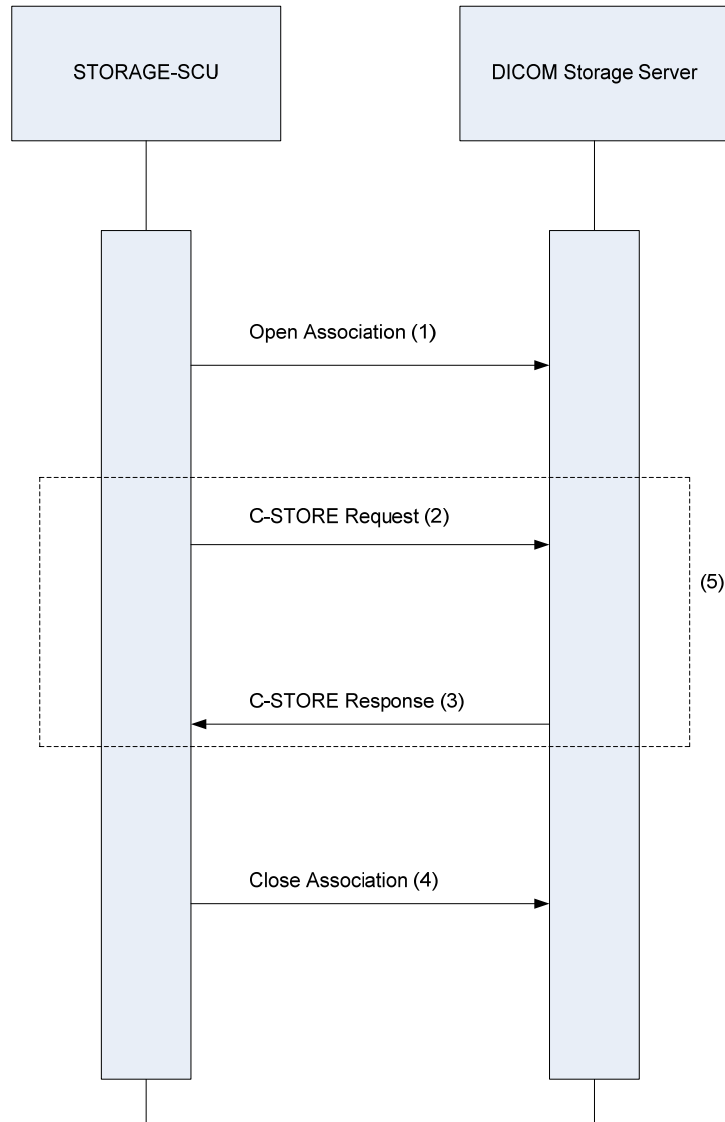

Figure 6 Storage SCU - Storage Request Sequence Diagram

6.2.3.3.3 Proposed Presentation Contexts

imageSPECTRUM Review STORAGE SCU is capable of proposing the Presentation Contexts shown in Table 6-26.

Table 6-26 Proposed Presentation Context: STORAGE SCU

Presentation Context Table				
Abstract Syntax		Transfer Syntax	Role	Extended Negotiation
Name	UID			
Secondary Capture Image Storage	1.2.840.10008.5.1.4.1.1.7	Table 6-7 ¹	SCU	None

6.2.3.3.4 SOP Specific Conformance for Storage SOP Classes

STORAGE SCU provides DICOM conformance to the storage service class.

The behavior of imageSPECTRUM Review’s STORAGE SCU is summarized in Table 6-27.

Table 6-27 Command Response Status Handling Behavior: STORAGE SCU

Status	Further Meaning	Error Code	Further Information
Success	Process complete.	0000	Message was received successfully.
Warning	One or more errors.	B000	Server returns response
Failure	Out of resources.	A700	Insufficient storage.
	Unable to process.	C000	Server returns response.

The behavior of imageSPECTRUM Review’s STORAGE SCU during communication failure is summarized in Table 6-28.

Table 6-28 Command Communication Failure Behavior: STORAGE SCU

Exception	Behavior
Timeout	The reason is logged.
Abort	The command is marked as failed. The reason is logged.

¹ Lossless not used during append function.

6.2.3.4 Association Acceptance Policy

The STORAGE SCU does not accept associations.

6.2.4 VERIFICATION SCU/SCP

6.2.4.1 Service Object Pair (SOP) Classes

The VERIFICATION SCU and VERIFICATION SCP AE's provide conformance to the following DICOM V3.0 SOP Classes.

Table 6-29 SOP Classes

SOP Class Name	SOP Class UID	SCU	SCP
Verification	1.2.840.10008.1.1	Yes	Yes

6.2.4.2 Association Policies

6.2.4.2.1 General

The DICOM Application Context shall be specified as detailed in Table 6-30.

Table 6-30 DICOM Application Context

Application Context Name	1.2.840.10008.3.1.1.1
--------------------------	-----------------------

6.2.4.2.2 Number of Associations

VERIFICATION SCU and VERIFICATION SCP accepts up to one simultaneous association establishment requests. See Table 6-31 and Table 6-32.

Table 6-31 Number of Associations as an Association Initiator

Maximum number of simultaneous associations	0
---	---

Table 6-32 Number of Associations as an Association Acceptor

Maximum number of simultaneous associations	1
---	---

6.2.4.2.3 Asynchronous Nature

Not Supported.

6.2.4.2.4 Implementation Identifying Information

Table 6-33 contains implementation identifying information for imageSPECTRUM Review.

Table 6-33 DICOM Implementation Class and Version

Implementation Class UID	a.b.c.xxxxxxx.yyy.zz
Implementation Version Name	1.2.828.0.1.3680043.2.60.0.1

6.2.4.3 Association Initiation Policy

6.2.4.3.1 Activity: Send Verification Request

6.2.4.3.2 Description and Sequencing of Activities

This application component transmits C-ECHO requests. imageSPECTRUM Review’s Verification SCU sends an Echo Request to verify that a Remote AE Title is active and responsive.

6.2.4.3.3 Proposed Presentation Contexts

imageSPECTRUM Review’s VERIFICATION SCU is capable of proposing the Presentation Contexts shown in Table 6-34.

Table 6-34 Proposed Presentation Context: VERIFICATION SCU

Presentation Context Table					
Abstract Context		Transfer Context		Role	Extended Negotiation
Name	UID	Name List	UID List		
Verification SOP Class	1.2.840.10008.1.1	Implicit VR Little Endian	1.2.840.10008.1.2	SCU	None
		Explicit VR Little Endian	1.2.840.10008.1.2.1		

6.2.4.3.4 SOP Specific Conformance for Verification SOP Class

DICOM conformance to the Verification Service Class as an SCU is provided.

6.2.4.4 Association Acceptance Policy

6.2.4.4.1 Activity: Receive Verification Request

6.2.4.4.2 Description and Sequencing of Activities

This application component responds to C-ECHO requests. A remote AE sends an Echo Request to verify that imageSPECTRUM Review is active and responsive. The Verification SCP responds with success status as long as the request is parsed.

6.2.4.4.3 Accepted Presentation Contexts

imageSPECTRUM Review’s VERIFICATION SCP is capable of accepting the Presentation Contexts shown in Table 6-35.

Table 6-35 Proposed Presentation Context: VERIFICATION SCP

Presentation Context Table					
Abstract Context		Transfer Context		Role	Extended Negotiation
Name	UID	Name List	UID List		
Verification SOP Class	1.2.840.10008.1.1	Implicit VR Little Endian	1.2.840.10008.1.2	SCP	None
		Explicit VR Little Endian	1.2.840.10008.1.2.1		

6.2.4.4.4 SOP Specific Conformance for Verification SOP Class

DICOM conformance to the Verification Service Class as an SCP is provided.

6.3 Network Interfaces

imageSPECTRUM Review provides DICOM V3.0 TCP/IP network communication support as stated in DICOM Standard Part 8. imageSPECTRUM Review inherits its TCP/IP stack from the OS upon which it executes.

6.3.1 Physical Network Interface

imageSPECTRUM Review utilizes the available network hardware using the installed OS interfaces.

6.3.1.1 IPv4 and IPv6 Support

imageSPECTRUM Review only supports IPv4 connections.

6.3.2 Additional Protocols

No additional protocols are used.

6.4 Configuration

6.4.1 AE Title Presentation Address Mapping

6.4.1.1 Local AE Titles

The local Calling AE Title is present as a value in the application configuration file. At this time setting the IP Address to 127.0.0.1 is not supported.

The local AE Title is presented in Table 6-36.

Table 6-36 AE Title Configuration Table

Application Entity	Default AE Title	Default TCP/IP Port
imageSPECTRUM Review	CLIENT1	5104

6.4.1.2 Remote AE Title/Presentation Address Mapping

Configuration of remote Server AE's and port numbers are present as values in the application configuration file. If imageSPECTRUM Server and the registered AE's are to be on the same computer, then the port value associated with the Registered AE Information MUST be different from the port value associated with the Server AE Information.

	WARNING: Setting the IP Address to 127.0.0.1 is <u>NOT</u> supported.
---	--

6.4.1.2.1 Configuration File Elements

The configuration file is titled Configuration.xml. Configuration elements are detailed in Table 6-37.

Table 6-37 Configuration Elements

XML element	Example value	Explanation
<NewDataSet xmlns="...">	<NewDataSet xmlns="http://CMS.Com.PS">	Set during the development process designates the xml namespace.
<Configuration>	Grouping element like a heading in a document. No value associated with this element other than sub elements and their values.	
Client Core Interface AE Information		
<AETitle>	CORE	Client interface AE Title. Can be modified by Client through the Q/R Server tab of System Administration.
<MaxPDUSize>	16384	Maximum size of the Protocol Data Unit.
<RootPath>	C:\PROCORE\	Parent folder for DICOM related processing.
<LogLevel>	3	Logging Level scale of 1-5, with 1 being the least logging and 5 being the most logging.
<LogDirPath>	Log\	Appended to the <RootPath> value to designate the folder containing the log file.
<SerializedDicomPath>	xmlDicom\	Appended to the <RootPath> value to designate the folder containing the serialized DICOM files.

XML element	Example value	Explanation
<MaxLogDiskSpace>	1000000000	Log file size in bytes.
<LogFlag>	True	Allow or disallow logging.
<ServiceClassSupport>	Grouping element. No value other than sub elements and their value.	
<Port>	104	Port associated with this service class.
<ARTim>	10000	Association State Machine Timeout interval in ms.
<LogLevel>	3	Logging Level scale of 1 - 5, with 1 being the least logging and 5 being the most logging.
<MaxQueueAssociations>	5	Maximum number of concurrent associations accepted.
<Enabled>	true	Ready or Idle state.
<ServiceClass>	Grouping element. No value other than sub elements and their value.	
<ServiceClassName>	Verification SOP Class	Enumerated value representing a Service Object Pair class type.
<LogLevel>	3	Logging Level scale of 1 - 5, with 1 being the least logging and 5 being the most logging.
<LogFlag>	True	Allow or disallow logging.

XML element	Example value	Explanation
Proxy and Multiple NIC Information		
<ProxyInfo>	Grouping element. No value other than sub elements and their value. This section is reserved for future development.	
<ProxyEnable>	False	Proxy server enabled.
<NodeInfo>	Grouping element. No value other than sub elements and their value. This section is reserved for future development.	
<IPAddress>	192.168.1.3	Proxy node IP Address.
<PortNumber>	1234	Proxy node port number.
<NICInfo>	Grouping element . No value other than sub elements and their value. This section is reserved for future development.	
<AdapterID>	0	Network Interface Card Adapter ID.
Server AE Information		
<CallingAEInfo>	Grouping element. No value other than sub elements and their value.	
<EntityTitle>	SERVER	The AE Title of the Q/R Server or Storage Server.

XML element	Example value	Explanation
<HostName> <IPAddress>	SERVER-1	The host name of the server or its IP Address. These elements when part of the <CallingAETitle> grouping, will always be the same for the imageSPECTRUM product classification.
<VerificationInterval>	600	Verification response timeout in ms.
<Accept>	True	Utilize the server if true, otherwise save the settings but do not associate.
<ServiceClassInfo>	Grouping element no value other than sub elements and their value.	
<Port>	104	Port associated with this service class.
<ARTim>	10000	Association State Machine Timeout interval in ms.
<LogLevel>	3	Logging Level scale of 1-5, with 1 being the least logging and 5 being the most logging.
<LogFlag>	True	Allow or disallow logging.
Modality Worklist Related Information		
<HL7Configuration>	Grouping element. No value other than sub elements and their value.	
<HL7IncomingPort>	123	HL 7 port

XML element	Example value	Explanation
<HL7Filter>		Grouping element. No value other than sub elements and their value.
<Segment>	Grouping element. No value other than sub elements and their value.	
<SegmentValue>	OBR	HL 7 segment identifier.
<Fields>		Grouping element. No value other than sub elements and their value.
<Field>	Grouping element. No value other than sub elements and their value.	
<FieldIndex>	30	Segment field index.
<SearchStrings>	Grouping element. No value other than sub elements and their value.	
<SearchString>	Unknown	Matching string.
<BodyPartPosition>		Grouping element. No value other than sub elements and their value.
<Segment>	OBR	The <Segment> element of the <BodyPartPosition> grouping represents the segment of the Body Part position HL 7 message.
<Field>	4	Field number.
<ComponentIndex>	3	Component index.

6.4.2 Parameters

Parameters related to acquisition and general operation are configurable via the application configuration file.

Table 6-38 shows only those configuration parameters relevant to DICOM communication.

Table 6-38 Configuration Parameters Table

Parameter	Configurable (Y/N)	Default Value
General Parameters		
Time-out waiting for acceptance or rejection response to an association open request. (application level timeout)	No	120 seconds
General DIMSE level time-out values.	No	120 seconds
Time-out waiting for response to TCP/IP connect request. (Low-level timeout)	OS system value	
Time-out waiting for acceptance of a TCP/IP message over the network. (Low-level timeout)	OS system value	
Time-out for waiting for data between TCP/IP packets. (Low-level timeout)	No	120 seconds
Any changes to default TCP/IP settings, such as configurable stack parameters.	No	N/A
AE Specific Parameters		
Size constraint in maximum object size.	Only limited by available memory.	
Maximum PDU size the AE can receive.	Yes	16k
Maximum PDU size the AE can send.	Yes	16k
AE specific DIMSE level time-out values.	Not configurable by AE.	
Number of simultaneous Associations by Service and/or SOP Class.	No	1

<p><SOP Class support> (e.g., Multi-frame vs. single frame vs. SC support when configurable)</p>	<p>Yes</p>	<p>Default SOP Class support – see Table 1-1. All SOP classes are accepted if configured.</p>
<p><Transfer Syntax support> (e.g., JPEG, Explicit VR when configurable)</p>	<p>For each presentation context: Selects a transfer syntax from those offered in the configuration file. Accepts any presentation context (whatever the SOP class) if there is a suitable transfer syntax.</p>	

7. MEDIA INTERCHANGE

Media interchange is not supported at this time.

8. SUPPORT OF CHARACTER SETS

imageSPECTRUM Review uses the Latin 1 (ISO_IR 100) character set exclusively.

9. SECURITY

9.1 Security Profiles

imageSPECTRUM Review does not support any specific security measures.

9.2 Association Level Security

imageSPECTRUM Review is used within a secure environment that includes a firewall designed so imageSPECTRUM Review only has network access to approved external hosts and services. Approved external hosts are entered into imageSPECTRUM Review configuration file.

9.3 Application Level Security

imageSPECTRUM Review utilizes user passwords intended to limit access to approved operators only. Password administration conforms to the following rules:

- Passwords consists of at least 6 characters and a maximum of 30 characters.

- At least one character of the password must be a letter.
- At least one character of the password must be a number.
- The password must be changed every 90 days.
- For new password selection, the last 5 passwords are ineligible as the new password.
- Roles of type Reviewer and Administrator are utilized to limit access to the imageSPECTRUM Review System Administration page.

10. ANNEXES

10.1 IOD Contents

10.1.1 Storage SCP AE Element Use

The following Elements of Composite SOP Instances received by the STORAGE SCP AE are of particular importance in the received images.

Series Laterality (0020,0060) may be used instead of Image Laterality (0020,0062) in order to facilitate the use of a laterality value of BOTH (B).

10.1.2 Usage of Attributes from Received IODs

imageSPECTRUM Review displays various attribute values associated with retrieved images. Table 6-16 contains the list of displayed attribute values.

10.1.3 Attribute Mapping

Series Laterality (0020,0060) may be used instead of Image Laterality (0020,0062) in order to facilitate the use of a laterality value of BOTH (B).

10.1.4 Coerced/Modified fields

No fields or coerced or modified.

Date and Time fields returned in a query response are not in UTC format.

10.2 Appending Images

The append function of the imageSPECTRUM Review application provides the user the ability to create a new screen image which is derived from original acquired images. This new screen image can be appended to the study using the “append” function.

In order to properly populate the study with a DICOM compliant image, the append function uses existing DICOM information contained in the original acquired images.

The first step involved in appending the study with a new image is to 'clone' the DICOM header information. The information from the first acquired image is used during the cloning process. See Figure 7.

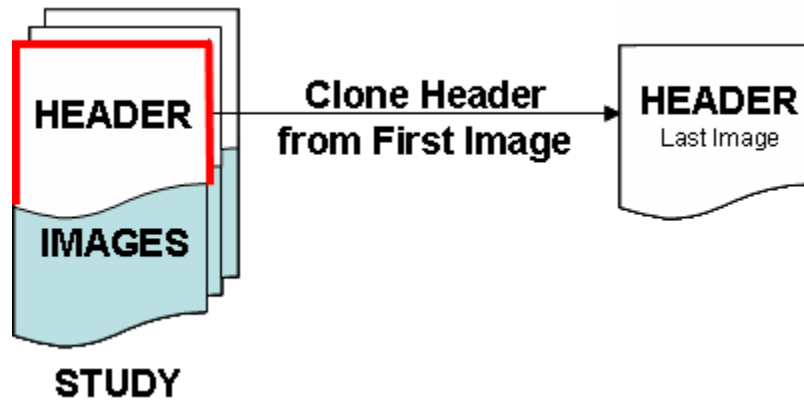

Figure 7 Clone DICOM Header

The next step in creating a new DICOM header is to replace and/or append specific DICOM elements. See Figure 8.

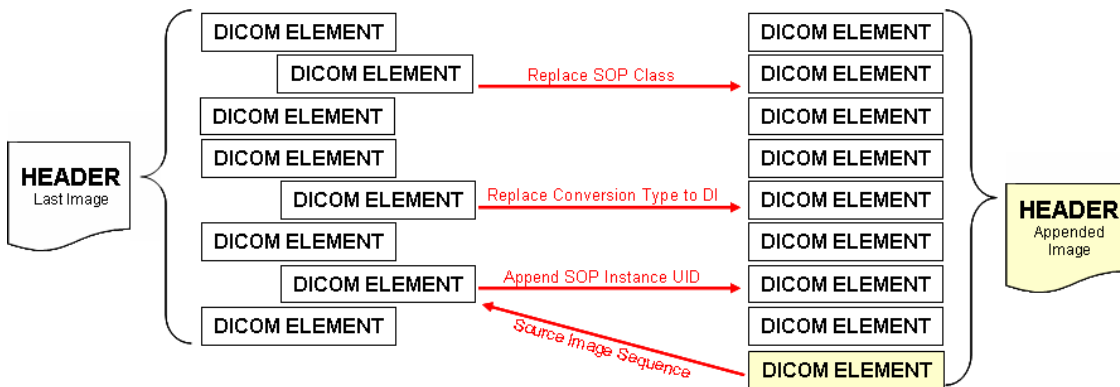

Figure 8 Create New DICOM Header

10.2.1.1 Altering DICOM Elements when Modality = OP

The following table (Table 10-1) illustrates which DICOM elements are changed and the rule associated with the alteration. Any cell under the “Action” column heading left blank is interpreted as “Clone”. Any value under the “Value” column heading is for example purposes only. The values under the “Rule” column heading refer to a specific action in regards to the specific DICOM tag. See Section 10.2.1.4 for an explanation of these rules.

Table 10-1 Altering DICOM Elements when Modality = OP

DICOM Element Description	Element	Group	Value	VR	Action	Rule
Transfer Syntax UID	10	2	1.2.840.10008.1.2.4.50	UI	Change	18
Image Type	8	8	DERIVED\SECONDARY	CS	Change	1
SOP Class UID	16	8	1.2.840.10008.5.1.4.1.1.77.1.5.1	UI	Change	2
SOP Instance UID	18	8	1.2.826.0.1.3680043.6.9427.13868.20070102111404.784.934	UI	Change	3
Study Date	20	8	1/2/2007	DA		
Series Date	21	8	1/2/2007	DA	Change	4
Image Date	23	8	1/2/2007	DA	Change	4
Acquisition Date-time	002A	8	1/2/2007 11:14:04 AM	DT		
Study Time	30	8	11:14:03 AM	TM		
Series Time	31	8	11:14:03 AM	TM	Change	4
Image Time	33	8	11:14:03 AM	TM	Change	4
Accession Number	50	8	7.01021E+12	SH		
Modality	60	8	OP	CS	Change	2
Conversion Type	64	8	DI	CS	Change	5
Manufacturer	70	8	Canon Medical Systems Canon USA	LO		
Institution Name	80	8	Default	LO	Change	6
Referring Physician's Name	90	8	Jo^Jo	PN		

DICOM Conformance Statement: imageSPECTRUM Review

DICOM Element Description	Element	Group	Value	VR	Action	Rule
Station Name	1010	8	CanonCaptureReview1	SH	Change	6
Study Description	1030	8	cataract	LO		
Series Description	103E	8	Image of Eye Lat: L	LO	Change	7
Institutional Department Name	1040	8		LO	Change	6
Operators' Name	1070	8	canon	PN	Change	8
Manufacturer's Model Name	1090	8	Eye Q Capture Review	LO	Change	9
Referenced SOP Class UID	1150	8	1.2.840.10008.5.1.4.1.1.77.1.5.1	UI	Change	24
Referenced SOP Instance UID	1155	8	1.2.826.0.1.3680043.6.9427.13868.20070102111404.784.934	UI	Change	24
Source Image Sequence	2112	8	<0><0><0>	SQ	Drop	16
Anatomic Region Sequence	2218	8	<T-AA000><SRT><Eye>	SQ	Drop	16
Patient's Name	10	10	DefaultOP^Delilah	PN		
Patient ID	20	10	010207-vir-134	LO		
Patient's Birth Date	30	10	9/9/1999	DA		
Patient's Sex	40	10	F	CS		
Ethnic Group	2160	10	White	SH		
Body Part Examined	15	18	Eye T-AA000 SRT	CS		
Device Serial Number	1000	18	1	LO	Drop	16
Software Version(s)	1020	18	1.0.0.9116	LO	Change	10
Digital Image Format Acquired	1023	18	JPEG Conversion	LO		
Protocol Name	1030	18		LO	Drop	16
Synchronization Trigger	106A	18	0	CS	Drop	16
Acquisition Time Synchronized	1800	18	11:14:04 AM	CS	Drop	16
Patient Position	5100	18		CS	Drop	16
View Position	5101	18		CS	Drop	16

DICOM Conformance Statement: imageSPECTRUM Review

DICOM Element Description	Element	Group	Value	VR	Action	Rule
Detector Type	7004	18	CMOS	CS	Drop	16
Study Instance UID	000D	20	1.2.826.0.1.3680043.6.12968.27057.20070102111321.784.903	UI		
Series Instance UID	000E	20	1.2.826.0.1.3680043.6.27197.23493.20070102111404.784.930	UI	Change	11
Study ID	10	20	EyeQCap109778669	SH		
Series Number	11	20	2	IS	Change	12
Image Number	13	20	2	IS	Change	13
Patient Orientation	20	20		CS	Change	14
Laterality	60	20	L	CS	Change	15
Image Laterality	62	20	L	CS	Change	15
Synchronization Frame of Reference UID	200	20	1.2.826.0.1.3680043.6.15322.4142.20070102111404.784.935	UI	Drop	16
Image Comments	4000	20		LT	Change	7
Patient Eye Movement Commanded	5	22	NO	CS	Drop	16
Patient Eye Movement Command Code Sequence	6	22	<0><SRT><0>	SQ	Drop	16
Spherical Lens Power	7	22	0	FL	Drop	16
Cylinder Lens Power	8	22	0	FL	Drop	16
Cylinder Axis	9	22	0	FL	Drop	16
Emmetropic Magnification	000A	22	0	FL	Drop	16
Intra Ocular Pressure	000B	22	0	FL	Drop	16
Horizontal Field of View	000C	22	0	FL	Drop	16
Pupil Dilated	000D	22	NO	CS	Drop	16
Degree of Dilation	000E	22	0	FL	Drop	16
Acquisition Device Type Code Sequence	15	22	<R-1021A><SRT><Fundus Camera>	SQ	Drop	16
Illumination Type Code Sequence	16	22	<R-1020E><SRT><Dual diffuse direct illumination>	SQ	Drop	16

DICOM Conformance Statement: imageSPECTRUM Review

DICOM Element Description	Element	Group	Value	VR	Action	Rule
Light Path Filter Type Stack Code Sequence	17	22	<111609><DCM><No filter>	SQ	Drop	16
Image Path Filter Type Stack Code Sequence	18	22	<111609><DCM><No filter>	SQ	Drop	16
Lenses Code Sequence	19	22	<0><SRT><0>	SQ	Drop	16
Channel Description Code Sequence	001A	22	<R-102C0><SRT><Full Spectrum>	SQ	Drop	16
Refractive State Sequence	001B	22	<0><0><0>	SQ	Drop	16
Mydriatic Agent Code Sequence	001C	22	<0><SRT><0>	SQ	Drop	16
Relative Image Position Code Sequence	001D	22	<0><SRT><0>	SQ	Drop	16
Samples per Pixel	2	28	3	US		
Photometric Interpretation	4	28	YBR_FULL_422	CS	Change	21
Planar Configuration	6	28	0	US		
Number of Frames	8	28	1	IS	Drop	16
Frame Increment Pointer	9	28	0	AT	Drop	16
Rows	10	28	2336	US	Change	19
Columns	11	28	3504	US	Change	19
Pixel Spacing	30	28	.30\30	DS	Drop	16
Bits Allocated	100	28	8	US		
Bits Stored	101	28	8	US		
High Bit	102	28	7	US		
Pixel Representation	103	28	0	US		
Burned In Annotation	301	28	NO	CS	Drop	16
Lossy Image Compression	2110	28	1	CS	Drop	16
Lossy Image Compression Ratio	2112	28	28	DS	Drop	16
Lossy Image Compression Method	2114	28	JPG	CS	Drop	16

DICOM Element Description	Element	Group	Value	VR	Action	Rule
Pixel Data	10	7FE0	Pixel Data	OB	Change	19
Private Tags	xx01 through xx35	70001	Private Tags for Reports – see Section 10.3, Table 10-4	LT	Add	25

10.2.1.2 Altering DICOM Elements when Modality = XC

The following table (Table 10-2) illustrates which DICOM elements are changed and the rule associated with the alteration. Any cell under the “Action” column heading left blank shall be interpreted as “Clone”. Any value under the “Value” column heading is for example purposes only. The values under the “Rule” column heading refer to a specific action which should be taken in regards to the specific DICOM tag. See Section 10.2.1.4 for an explanation of these rules.

Table 10-2 Altering DICOM Elements when Modality = XC

DICOM Element Description	Element	Group	Value	VR	Action	Rule
Transfer Syntax UID	10	2	1.2.840.10008.1.2.4.50	UI	Change	18
Image Type	8	8	DERIVED\SECONDARY	CS	Change	1
SOP Class UID	16	8	1.2.840.10008.5.1.4.1.1.7	UI	Change	2
SOP Instance UID	18	8	1.2.826.0.1.3680043.6.20486.8762.20070102111404.784.926	UI	Change	3
Study Date	20	8	1/2/2007	DA		
Series Date	21	8	1/2/2007	DA	Change	4
Image Date	23	8	1/2/2007	DA	Change	4
Study Time	30	8	11:14:03 AM	TM		
Series Time	31	8	11:14:03 AM	TM	Change	4
Image Time	33	8	11:13:52 AM	TM	Change	4
Accession Number	50	8	7.01021E+12	SH		
Modality	60	8	XC	CS		

DICOM Conformance Statement: imageSPECTRUM Review

DICOM Element Description	Element	Group	Value	VR	Action	Rule
Conversion Type	64	8	DI	CS	Change	20
Manufacturer	70	8	Canon Medical Systems Canon USA	LO		
Institution Name	80	8	Default	LO	Change	6
Referring Physician's Name	90	8	Jo^Jo	PN		
Station Name	1010	8	CanonCaptureReview1	SH	Change	6
Study Description	1030	8	cataract	LO		22
Series Description	103E	8	Image of Eye Lat: B OP Chart	LO	Change	7
Institutional Department Name	1040	8		LO	Change	6
Performing Physician's Name	1050	8	Administrator	PN		22
Operator's Name	1070	8	canon	PN	Change	8
Manufacturer's Model Name	1090	8	Eye Q Capture Review	LO	Change	9
Referenced SOP Class UID	1150	8	1.2.840.10008.5.1.4.1.1.77.1.5.1	UI	Add	17
Referenced SOP Instance UID	1155	8	1.2.826.0.1.3680043.6.9427.13868.20070102111404.784.934	UI	Add	17
Source Image Sequence	2112	8	<0><0><0>	SQ	Drop	16
Patient's Name	10	10	DefaultOP^Delilah	PN		
Patient ID	20	10	010207-vir-134	LO		
Patient's Birth Date	30	10	9/9/1999	DA		
Patient's Sex	40	10	F	CS		
Patient's Age	1010	10	060Y	AS		22
Ethnic Group	2160	10	White	SH		22
Body Part Examined	15	18	EYE	CS		22
Device Serial Number	1000	18	1	LO	Drop	16
Software Version(s)	1020	18	1.0.0.9116	LO	Change	10
Digital Image Format Acquired	1023	18	JPEG Conversion	LO		

DICOM Conformance Statement: imageSPECTRUM Review

DICOM Element Description	Element	Group	Value	VR	Action	Rule
Protocol Name	1030	18		LO		
View Position	5101	18		CS		22
Study Instance UID	000D	20	1.2.826.0.1.3680043.6.12968.27057.20070102111321.784.903	UI		
Series Instance UID	000E	20	1.2.826.0.1.3680043.6.18198.28607.20070102111404.784.922	UI	Change	11
Study ID	10	20	EyeQCap109778669	SH		
Series Number	11	20	3	IS	Change	12
Acquisition Number	12	20	1	IS		22
Image Number	13	20	1	IS	Change	13
Patient Orientation	20	20	L/F	LO	Drop	16
Laterality	60	20	B	CS	Change	15
Image Laterality	62	20	B	CS	Change	15
Image Comments	4000	20		LT	Change	7
Samples per Pixel	2	28	3	US	Change	23
Photometric Interpretation	4	28	YBR_FULL_422	CS	Change	21
Planar Configuration	6	28	0	US		
Rows	10	28	664	US	Change	19
Columns	11	28	1208	US	Change	19
Bits Allocated	100	28	8	US		
Bits Stored	101	28	8	US		
High Bit	102	28	7	US		
Pixel Representation	103	28	0	US		
Window Center	1050	28	128	DS	Drop	16
Window Width	1051	28	256	DS	Drop	16
LossyImageCompression	2110	28	00	CS	Drop	16

DICOM Element Description	Element	Group	Value	VR	Action	Rule
Acquisition Context Sequence	0555	40	Null	CS	Drop	16
Pixel Data	10	7FE0	Pixel Data	OB	Change	19
Private Tags	xx01 through xx35	70001	Private Tags for Reports – see Section 10.3, Table 10-4	LT	Add	25

10.2.1.3 Altering DICOM Elements when Modality = OT

The following table (Table 10-3) illustrates which DICOM Elements are changed and the rule associated with the alteration. Any cell under the “Action” column heading left blank shall be interpreted as “Clone”. Any value under the “Value” column heading is for example purposes only. The values under the “Rule” column heading refer to a specific action which should be taken in regards to the specific DICOM tag. See Section 10.2.1.4 for an explanation of these rules.

Table 10-3 Altering DICOM Elements when Modality = OT

DICOM Element Description	Element	Group	Value	VR	Action	Rule
Transfer Syntax UID	10	2	1.2.840.10008.1.2.4.50	UI	Change	18
Image Type	8	8	DERIVED\SECONDARY	CS	Change	1
SOP Class UID	16	8	1.2.840.10008.5.1.4.1.1.7	UI	Change	2
SOP Instance UID	18	8	1.2.826.0.1.3680043.6.20486.8762.20070102111404.784.926	UI	Change	3
Study Date	20	8	1/2/2007	DA		
Series Date	21	8	1/2/2007	DA	Change	4
Image Date	23	8	1/2/2007	DA	Change	4
Study Time	30	8	11:14:03 AM	TM		
Series Time	31	8	11:14:03 AM	TM	Change	4
Image Time	33	8	11:13:52 AM	TM	Change	4
Accession Number	50	8	7.01021E+12	SH		

DICOM Conformance Statement: imageSPECTRUM Review

DICOM Element Description	Element	Group	Value	VR	Action	Rule
Modality	60	8	OT	CS		
Conversion Type	64	8	DI	CS	Change	20
Manufacturer	70	8	Canon Medical Systems Canon USA	LO		
Institution Name	80	8	Default	LO	Change	6
Referring Physician's Name	90	8	Jo^Jo	PN		
Station Name	1010	8	CanonCaptureReview1	SH	Change	6
Study Description	1030	8	cataract	LO		22
Series Description	103E	8	Image of Eye Lat: B OP Chart	LO	Change	7
Institutional Department Name	1040	8		LO	Change	6
Performing Physician's Name	1050	8	Administrator	PN		22
Operator's Name	1070	8	canon	PN	Change	8
Manufacturer's Model Name	1090	8	Eye Q Capture Review	LO	Change	9
Referenced SOP Class UID	1150	8	1.2.840.10008.5.1.4.1.1.77.1.5.1	UI	Add	17
Referenced SOP Instance UID	1155	8	1.2.826.0.1.3680043.6.9427.13868.20070102111404.784.934	UI	Add	17
Source Image Sequence	2112	8	<0><0><0>	SQ	Drop	16
Patient's Name	10	10	DefaultOP^Delilah	PN		
Patient ID	20	10	010207-vir-134	LO		
Patient's Birth Date	30	10	9/9/1999	DA		
Patient's Sex	40	10	F	CS		
Patient's Age	1010	10	060Y	AS		22
Ethnic Group	2160	10	White	SH		22
Body Part Examined	15	18	EYE	CS		22
Device Serial Number	1000	18	1	LO	Drop	16
Software Version(s)	1020	18	1.0.0.9116	LO	Change	10

DICOM Conformance Statement: imageSPECTRUM Review

DICOM Element Description	Element	Group	Value	VR	Action	Rule
Digital Image Format Acquired	1023	18	JPEG Conversion	LO		
Protocol Name	1030	18		LO		
View Position	5101	18		CS		22
Study Instance UID	000D	20	1.2.826.0.1.3680043.6.12968.27057.20070102111321.784.903	UI		
Series Instance UID	000E	20	1.2.826.0.1.3680043.6.18198.28607.20070102111404.784.922	UI	Change	11
Study ID	10	20	EyeQCap109778669	SH		
Series Number	11	20	3	IS	Change	12
Acquisition Number	12	20	1	IS		22
Image Number	13	20	1	IS	Change	13
Patient Orientation	20	20	L/F	LO	Drop	16
Laterality	60	20	B	CS	Change	15
Image Laterality	62	20	B	CS	Change	15
Image Comments	4000	20		LT	Change	7
Samples per Pixel	2	28	3	US	Change	23
Photometric Interpretation	4	28	YBR_FULL_422	CS	Change	21
Planar Configuration	6	28	0	US		
Rows	10	28	664	US	Change	19
Columns	11	28	1208	US	Change	19
Bits Allocated	100	28	8	US		
Bits Stored	101	28	8	US		
High Bit	102	28	7	US		
Pixel Representation	103	28	0	US		
Window Center	1050	28	128	DS	Drop	16
Window Width	1051	28	256	DS	Drop	16

DICOM Conformance Statement: imageSPECTRUM Review

DICOM Element Description	Element	Group	Value	VR	Action	Rule
Rescale Intercept	1052	28	0	DS	Drop	16
Rescale Slope	1053	28	1	DS	Drop	16
Rescale Type	1054	28	US	LO	Drop	16
Pixel Data	10	7FE0	Pixel Data	OB	Change	19
Private Tags	xx01 through xx35	70001	Private Tags for Reports – see Section 10.3, Table 10-4	LT	Add	25

10.2.1.4 Rules of Alteration

During the append process, the new image adopts the header information from one of the original images in the study. This information may not be relevant to the new image. When a particular DICOM element (tag) is altered it may be changed, dropped or added. Depending on the type of alteration, a specific rule is applied. The following describes the nature of these rules:

Rule Number	Type	Description
1	Change	Value shall always be Derived\Secondary.
2	Change	Value shall always be XC (1.2.840.10008.5.1.4.1.1.7).
3	Change	Value shall always be the value of the DICOMimplementationclass UID, followed by a period (.), followed by year-month-day, followed by a period (.), followed by milliseconds since midnight.
4	Change	Change to the current date or time (which ever applies).
5	Change	Value shall always be DI.
6	Change	Value shall always be the Station Name, Institution Name and Institution Department Name under the My Station Information heading on the Query Retrieve tab .
7	Change	Value shall always read, "Appended Image(s)".
8	Change	Value shall always be the login name.
9	Change	Value shall always read, "imageSPECTRUM".
10	Change	Value shall always reflect the version of the current imageSPECTRUM Review application.
11	Change	All appended images shall be grouped together under the same Study Instance UID, therefore, the Series Instance UID for appended images shall be unique for each image.
12	Change	All appended images shall be grouped together under the same Series Number; therefore, the Series Number for the appended images shall be "99".

- | | | |
|-----------|--------|--|
| 13 | Change | All appended images shall be numbered sequentially, beginning from (1). For sorting purposes, the image number will always be used in conjunction with the Series Instance UID. |
| 14 | Change | Change to AP for anterior-posterior orientation. |
| 15 | Change | The Image Laterality for all appended images shall be "B". |
| 16 | Drop | Drop DICOM Element. |
| 17 | Add | Add DICOM Element. These values should reference the image or images from which the cloned information set was derived from. Appended reports will contain the SOP Class UID and SOP Instance UID for each dataset of the study. The referenced attributes will be contained within a Referenced Study Sequence (0008,1110). |
| 18 | Change | The Transfer Syntax UID will reflect the transfer syntax required for the appended image. |
| 19 | Change | The Rows, Columns, and Pixel Data will reflect the appended image. |
| 20 | Change | Add this tag if not present with value DI. |
| 21 | Change | Always change to RGB. |
| 22 | Clone | Some attributes are not always present, therefore, when attribute is present clone, otherwise disregard. |
| 23 | Change | Always change to 3. |
| 24 | Change | These values should reference the image or images from which the cloned information set was derived from. Appended reports will contain the SOP Class UID and SOP Instance UID for each dataset of the study. The referenced attributes will be contained within a Referenced Study Sequence (0008,1110). |
| 25 | Add | These values are described in Section 10.3, Table 10-4. Appended reports will contain these private tags. |

10.2.1.5 SOP Instance UID

The SOP Instance UID created for appended images shall adhere to the following syntax;

1.2.828.0.1.3680043.'yearmonthday'. 'millisecondssincemidnight'.

The 'yearmonthday' syntax shall adhere to, YYYYMMDD.

10.3 Data Dictionary of Private Attributes

imageSPECTRUM Review shall support private attributes. Review shall specifically use private attributes in the 0x7001 group and use "1.2.828.0.1.3680043.2.60.0.1" as the private attribute implementation identifier.

Private Attributes are used to preserve report values for future retrievals. The Group Number for all Private Attributes is 7001. Some fields will contain more than one Group Element pair because these field values can be modified by the user while creating a report; the original field values will not be modified, only the Private Attributes will contain the values set during report creation.

10.3.1 Report Elements

The following elements are listed in Table 10-4 and are contained within the **Report Form**.

10.3.2 Category

A distinct area within the **Report Form**.

10.3.3 Field Name

Refers to the various labels shown on the **Report Form**. Note that there is a potential for the facility field to not have a unique value due to conformance to the DICOM tag (0008,0080) making it an element of a General Equipment module. For this reason, the facility used for display will be the facility found in the tag associated with the first image in the image display list.

10.3.4 Tag

Private Attributes are used to preserve report values for future retrievals. The Group Number for all Private Attributes is 7001. "R" and "L" following the Element Number refers to the right or left eye. Some fields will contain more than one Group Element pair because these field values can be modified by the user while creating a report; the original field values will not be modified, only the Private Attributes will contain the values set during report creation.

10.3.5 Type

Refers to the type and method of the input data.

10.3.5.1 String

Refers to free text manually entered by the user.

10.3.5.2 List

Refers to a list box with various list items displayed. The first list item shall be the default value presented.

10.3.5.3 Radio

Refers to a set of radio buttons. The first list item shall be the default value presented.

10.3.6 Value/Enumeration

Where applicable, the enumerated value is listed. Not all Field Names have a DICOM tag associated with it, however, the Value stated is used as a reference. All tags with a group number of 7001 will have a value/enumeration of "LT" used as stored values in the patient report.

10.3.7 Length

Refers to the length of the attribute value supported.

Table 10-4 Report Form Elements and Values

Category	Field Name	Tag	Type	Value / Enumeration	Length (characters)
Demographics					
	Patient Name	(0010,0010)	String	PN	64
	Ethnicity	(0010,2160)	String	CS	16
	Gender	(0010,0040)	List	CS - blank - M - F - O	1
	DOB	(0010,0030)	String	DA	10
	Patient ID	(0010,0020)	String	LO	64
	Age at time of report	(7001,xx01)	String	AS	4
	Report Date	N/A	String	DA	10
	Patient Address	(7001,xx2E)	String	LO	25

Category	Field Name	Tag	Type	Value / Enumeration	Length (characters)
	Patient City	(7001,xx2F)	String	LO	20
	Patient State	(7001,xx30)	String	SH	2
	Patient Zipcode	(7001,xx31)	String	SH	5
	Patient Phone Number-1	(7001,xx32)	String	SH	16
	Patient Phone Number-2	(7001,xx33)	String	SH	16
	Patient Email	(7001,xx34)	String	LO	32
	Patient Full Address String	(7001,xx35)	String	LT	64
Study Information					
	Accession Number	(0008,0050)	String	SH	16
	Physician	(0008,0090)	String	PN	64
	Exam Date	(0008,0020)	String	DA	10
	Facility	(0008,0080)	String	LO	64
History					
	Interval	(7001,xx1E)	String	PN	64
	Family	(7001,xx14)	String	PN	64
	Ocular	(7001,xx24)	String	PN	64
	Allergies	(7001,xx02)	String	PN	64
	Medications	(7001,xx21)	String	PN	64
	BMI	(7001,xx18)	String	SH	4
	Bp-Systolic	(7001,xx1B)	String	SH	4
	Bp-Diastolic	(7001,xx1A)	String	SH	4
	Full Bp String	(7001,xx1C)	String	LT	10
	BGL	(7001,xx19)	String	SH	4
	HbA1C	(7001,xx17}	String	SH	4

Category	Field Name	Tag	Type	Value / Enumeration	Length (characters)
Findings					
	IOP (mmHg)	(0022,000B) (7001,xx20)R (7001,xx1F)L	List	FL - 0 through 26	2
	Sphere	(0022,0007) (7001,xx2D)R (7001,xx2C)L	String	FL	6
	Cylinder	(0022,0008) (7001,xx0B)R (7001,xx0A)L	String	FL	6
	Axis	(0022,0009) (7001,xx03)R (7001,xx04)L	String	FL	6
	Image Quality	(7001,xx27)R (7001,xx28)L	List	LT - Excellent - Good - Fair - Poor	9
	Corneal Thickness	(7001,xx09)R (7001,xx08)L	String	SH	8
	Disc Diameter Ratio	(7001,xx11)R (7001,xx36)L ²	String	SH	4
	Enucleated	(7001,xx13)R (7001,xx12)L	Check box	LT - Not Checked - Checked	NULL
	Small Pupil	(7001,xx2A)R (7001,xx29)L	Radio	LT - N - Y	NULL

² There is no DICOM tag for this field as the data is supplied internally by the Cup To Disc Ratio Tool. Note that if there is multiple Cup To Disc information within one laterality; Report will provide a drop down list to choose from.

Category	Field Name	Tag	Type	Value / Enumeration	Length (characters)
	Dilated	(0022,000D) (7001,xx0C)R (7001,xx0D)L	Radio	CS - N - Y	NULL
	Degree of Dilation	(0022,000E) (7001,xx0F)R (7001,xx0E)L	String	SH	8
	Mydriatic Agent	(0022,001C) (7001,xx23)R (7001,xx22)L	List	SQ - None - Atropine - Homatropine - - Cyclopentolate - Phenylephrine - Tropicamide	16
	Condition	(7001,xx07)R (7001,xx06)L	List	LT - AMD (Dry) - AMD (Wet) - Glaucoma - Corneal Degeneration - Age Related Drusen - Cataract - Asteroid Hyalosis - Macular Degeneration - Media Opacity - Myelinated Nerve Fiber - Optic Atrophy - Pigmentation - Disc Cupping - Other	32

Category	Field Name	Tag	Type	Value / Enumeration	Length (characters)
	Grade	(7001,xx16)R (7001,xx15)L	List	LT - Ungradeable - No Apparent Retinopathy - Mild Non-proliferative DR - Moderate Non-proliferative DR - Severe Non-proliferative DR - Proliferative DR - Non-VTD - VTD - Maculopathy - Photo-coagulation	32
Outcome					
	Refer To	(7001,xx25)	List	LT - Refer to Optometry - Refer to Urgent Cataract - Refer to Urgent Glaucoma - Refer to Urgent Retina	32

Category	Field Name	Tag	Type	Value / Enumeration	Length (characters)
	Recall	(7001,xx26)	List	LT - Annual Recall - One Month Recall - Six Month Recall - Three Month Recall - One Day Recall	32
	ICD-9	(7001,xx1D)	String	Alphanumeric	16
	SNOMED	(7001,xx2B)	String	Alphanumeric	16
Comments					
	Text Box	(7001,xx05)	String	Alphanumeric	270

10.4 Coded Terminology and Templates

The imageSPECTRUM Review is not using any Codes (SNOMED) or Controlled Terminology, such as the use of the DICOM Content Mapping Resource (DCMR).

10.4.1 Template Specifications

Templates are not used by imageSPECTRUM Review.

10.4.2 Private Code definitions

No private codes are used by imageSPECTRUM Review.

10.5 Grayscale Image Consistency

The DICOM Grayscale Standard Display Function is not supported by imageSPECTRUM Review.

10.6 Standard Extended/Specialized/Private SOP Classes

There is no Standard Extended SOP Class, Specialized SOP Class, or Private SOP Class used by imageSPECTRUM Review.

10.7 Private Transfer Syntaxes

No private Transfer Syntaxes are used by imageSPECTRUM Review.